



## MANTA BARRIER END STOP INSTALLATION GUIDE

Installing the Manta Barrier could not be faster or simpler. Simply line the barriers up and slot in the connecting pin to secure in place.

People to Install:



Equipment / Accessories Needed:

- Connection pin

**1**

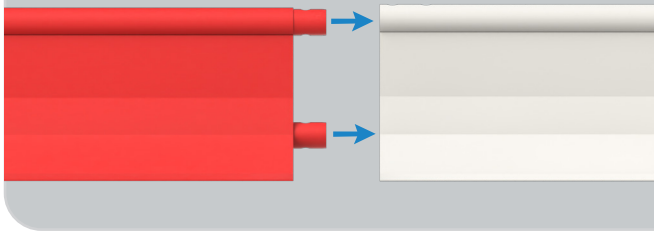

Place the barriers side by side, so that the holes align.

**2**



When connected the barriers form a snug bond without gaps.

**3**

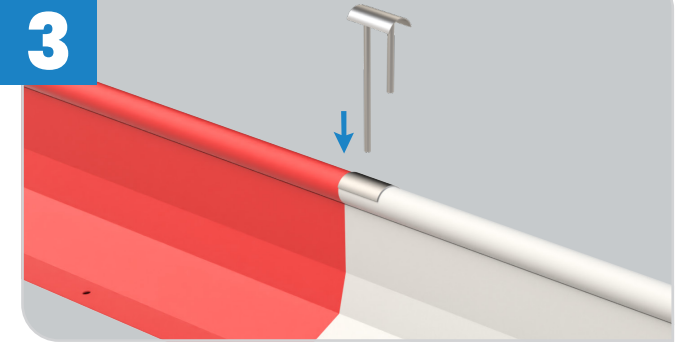

Once the barriers are in place, the connecting pin slots down through the top of the barrier to hold in place.

**4**

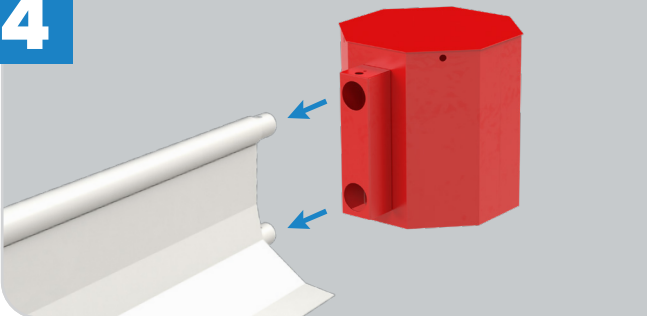

To finish the barriers in a line butt the end stop into the end of the barrier.

**5**

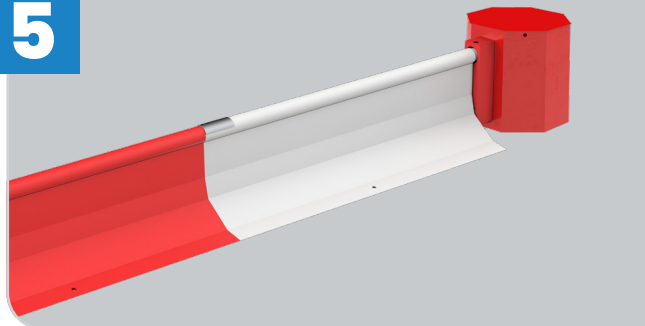

The ends top completes the run of barriers for a neat and tidy finish.





## MANTA BARRIER PEDESTRIAN FENCE INSTALLATION GUIDE

Manta barriers will last for the full lifetime of your project, whether you're involved in street works, road or highway works, traffic management, construction sites, car parks or events.

People to Install:



Equipment / Accessories Needed:

- Standard coupler

**1**

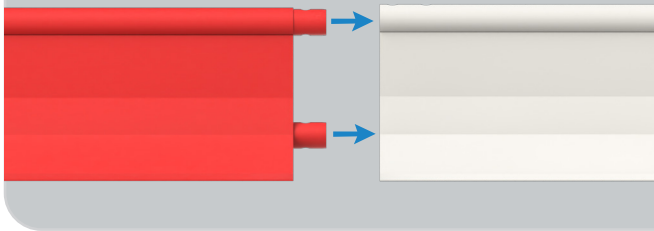

Place the barriers side by side, so that the holes align.

**2**

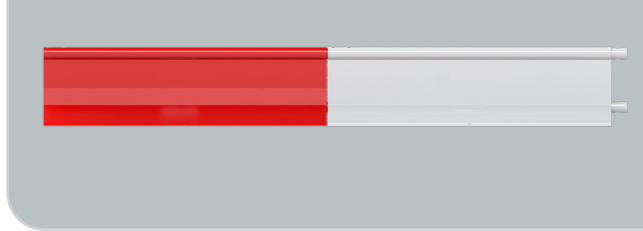

When connected the barriers form a snug bond without gaps.

**3**

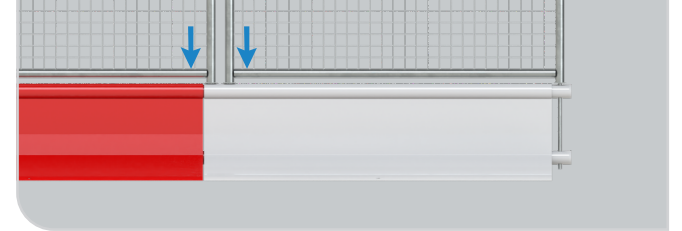

The pedestrian and vis rails/guards slot neatly into the top of the barriers and no additional pins are needed.

**4**

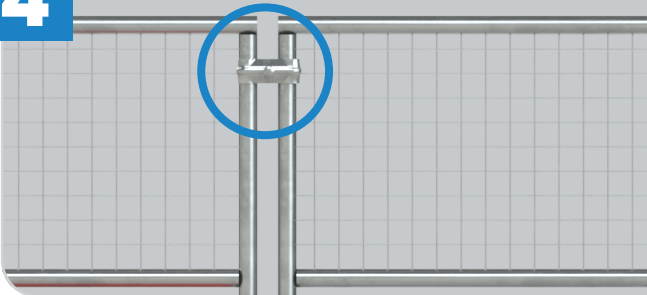

Secure the panels in place using a standard coupler.

**5**

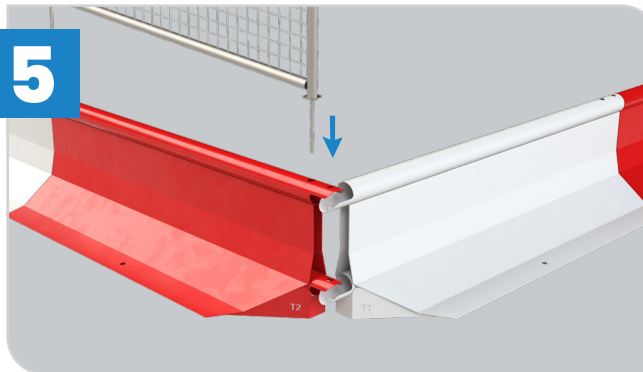

Corner barriers can be attached to the standard barriers. Simply line up the ends and insert the connecting or fence panel leg. You will need both T1 and T2 versions to complete the corner.

**6**

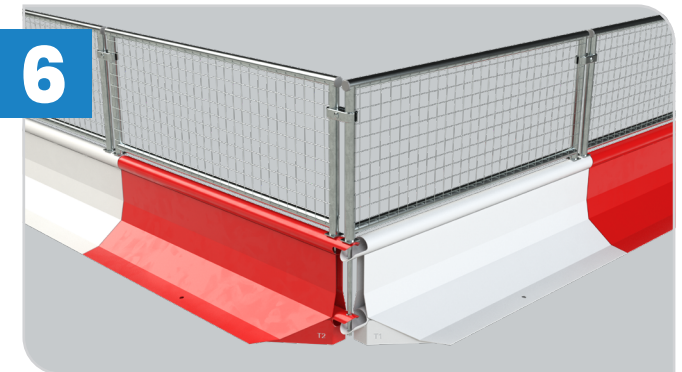

The leg of the fence panel doubles-up as a support strut to hold the corner angles/barriers in place.





## MANTA BARRIER

### 3m FENCE INSTALLATION GUIDE

Installing the Manta Barrier could not be faster or simpler. Simply line the barriers up and slot in the connecting pin to secure in place.

People to Install:



Equipment / Accessories Needed:

- 2 x Standard Coupler
- Connection pin
- 3m Fencing panel

1

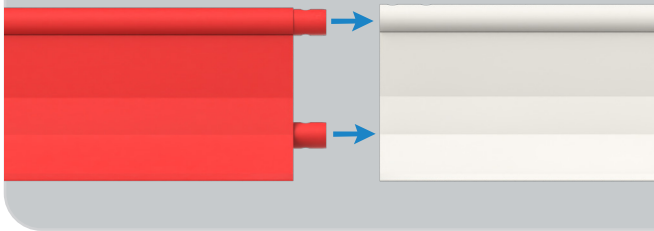

Place the barriers side by side, so that the holes align.

2

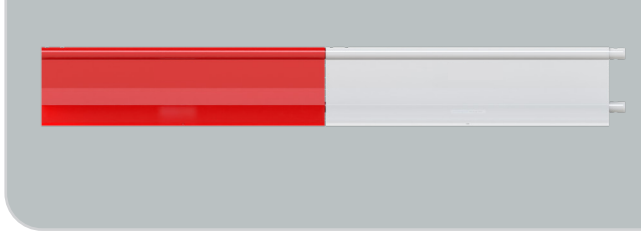

When connected the barriers form a snug bond without gaps.

3

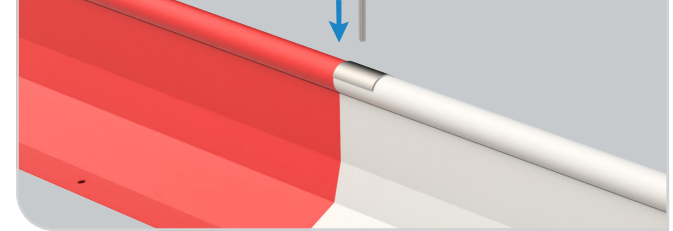

Once the barriers are in place, the connecting pin slots down through the top of the barrier to hold in place.

4

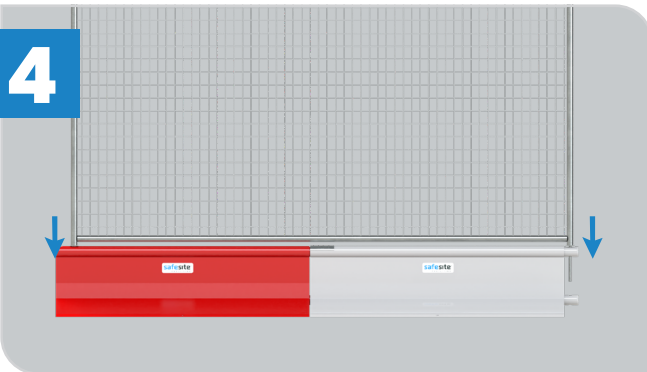

With the connecting pin in place, you can then slot the fence panel legs into place so that it straddles 2 consecutive barriers.

5

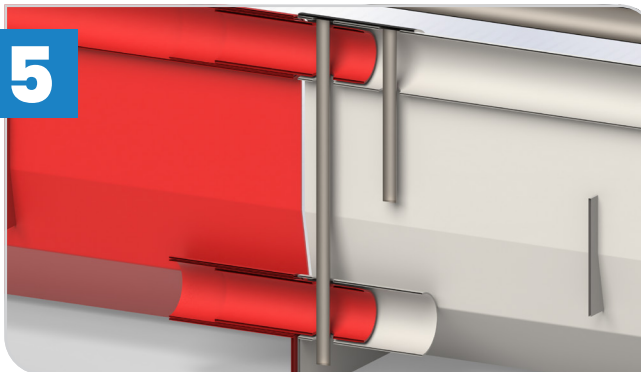

See above for a close up of how the barriers connect together when you add a fence panel.

6

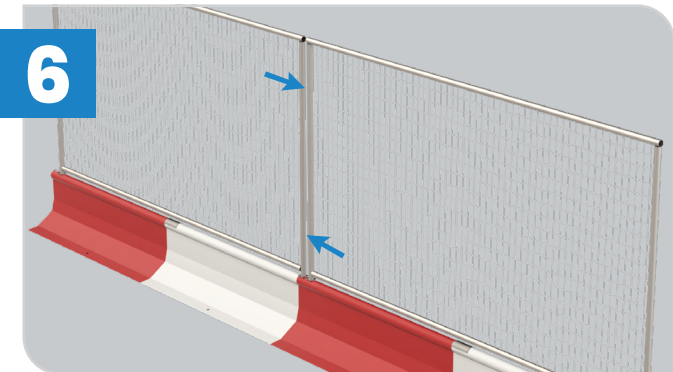

2 Standard Couplers should be used to secure the Fence panels together.



**Useful Tip:** Remember to put the connecting pin in the barriers before adding the SiteGuard mesh fence panels.



Wear the appropriate PPE for this task



## MANTA BARRIER GATE INSTALLATION GUIDE

Manta barriers will last for the full lifetime of your project, whether you're involved in street works, road or highway works, traffic management, construction sites, car parks or events.

People to Install:



Equipment / Accessories Needed:

- 6 x Couplers
- Pedestrian gate
- Manta adaption pole & slam bar

7

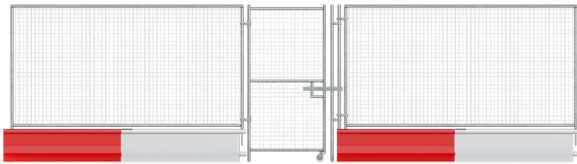

Gates can be easily added to the manta barrier system. Simply create a break in the line of barriers

8

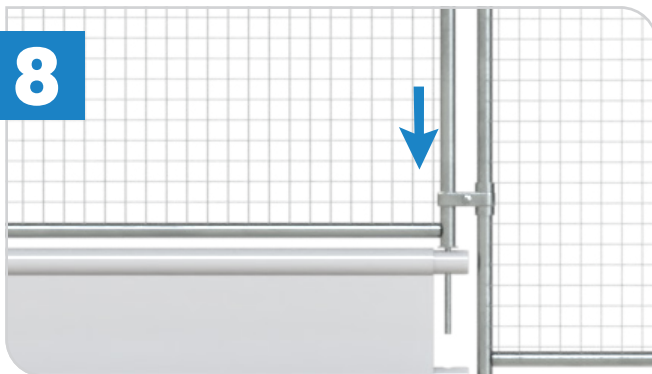

Slot the mesh fence panels into the top of the manta barriers as normal.

9

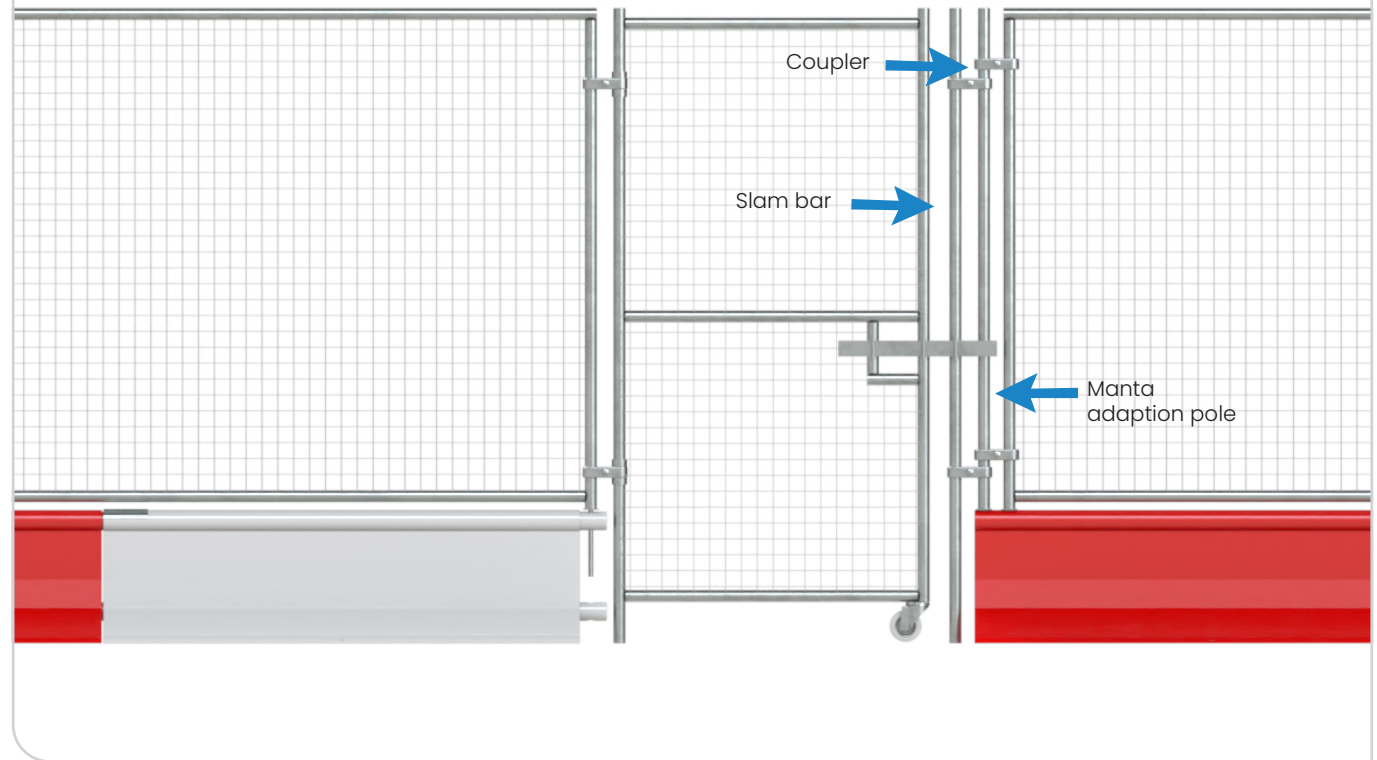

Attach the loose gate hinges to the fence panel on the left using 2 couplers. On the right install the adaption pole in the free hole and then use couplers to attach the slam post.

The slam post should be install so that the gate latch meets the loop on the slam post.



**Useful Tip:** If you're unsure of the parts and accessories required - our friendly sales team will gladly help with everything you need.



Wear the appropriate PPE for this task.



# MANTA BARRIER HOARDING INSTALLATION GUIDE

Manta barriers will last for the full lifetime of your project, whether you're involved in street works, road or highway works, traffic management, construction sites, car parks or events.

People to Install:



Equipment / Accessories Needed:

- 3 x HD couplers
- Hoarding Panels
- Hoarding Stabiliser

**1**

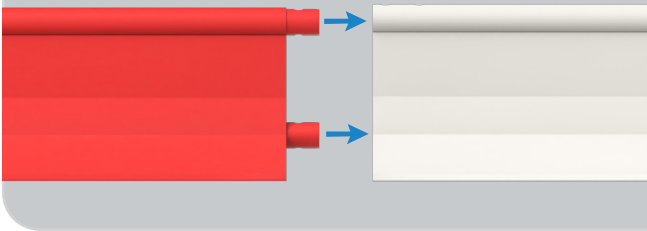

Place the barriers side by side, so that the holes align.

**2**

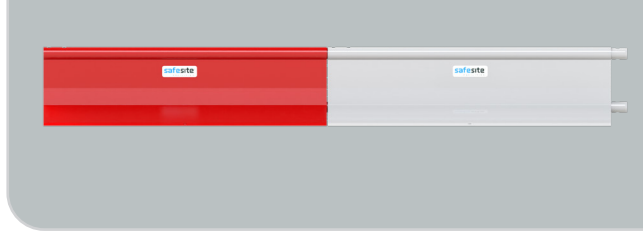

When connected the barriers form a snug bond without gaps.

**3**

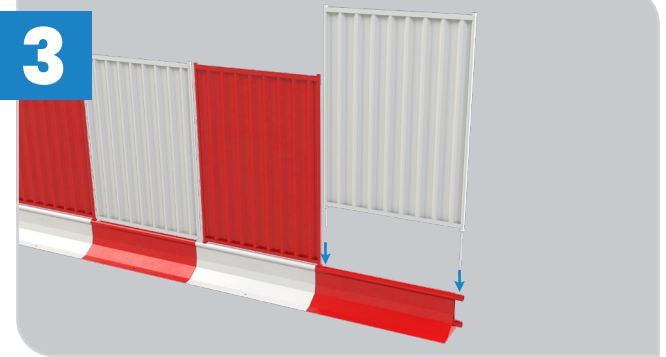

The Hoarding panels slot neatly into the top of the barriers and no additional connector pins are needed.

**4**

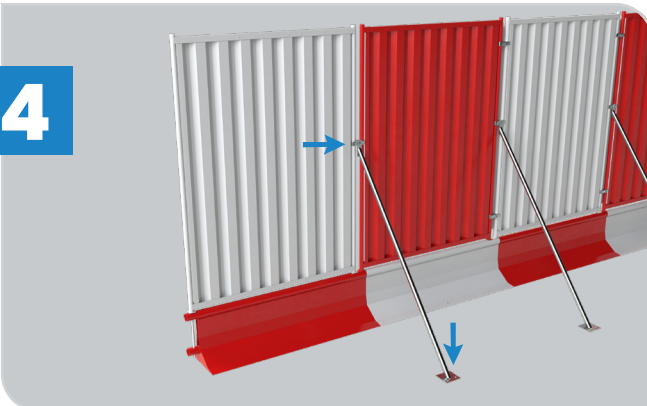

Secure the panels in place using a HD coupler at a height of 1.5m from the ground. Using the same coupler bolt attach the stabiliser as shown, the base of the stabiliser should be attached to the ground using chemical anchors of at least M12 x 110mm.

**5**



Infill panels can be added using 2 couplers top and bottom.

**6**

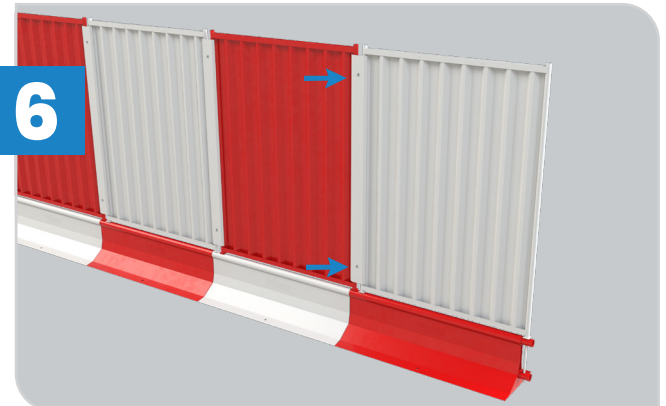

When complete this will cover the middle coupler previously added.

